



# M3 Shelving for picking

for light and medium loads



A basic manual storage and archive system for light and medium loads. Combining the different components offers a whole range of features.

#### The main advantages are:

- **Endless storage possibilities** from plain folders to all kinds of parts, boxes, clothes, bulk goods, etc.
- **Multiple components** that adapt to suit even the most demanding needs.
- **Easy to assemble.**
- **Level adjustments** in multiples of 25 mm.
- Increased capacity due to the fact that **minimal space** is used for uprights and shelf panels.
- It is possible to install **one or more walkways** to gain access to upper levels.
- **Mobile shelving** can be made for archives and warehouses.
- **Functional and attractive.** For the office version, the units can be finished to suit your decor.





# Components

A plethora of components that adapt to any requirement

## Basic components

1. Frame (5 models)
2. Shelf (3 models)
3. Shelf support
4. Cross bracing set
5. Frame union
6. Footplate (2 models)



Plastic bins



Suspension filing sets

## Optional components

7. Back panel (in metal sheet or mesh)
8. Shelf retainer and plinth
9. Vertical divider
10. Plastic drawer
11. Door
12. Suspension filing set
13. Garment rail set

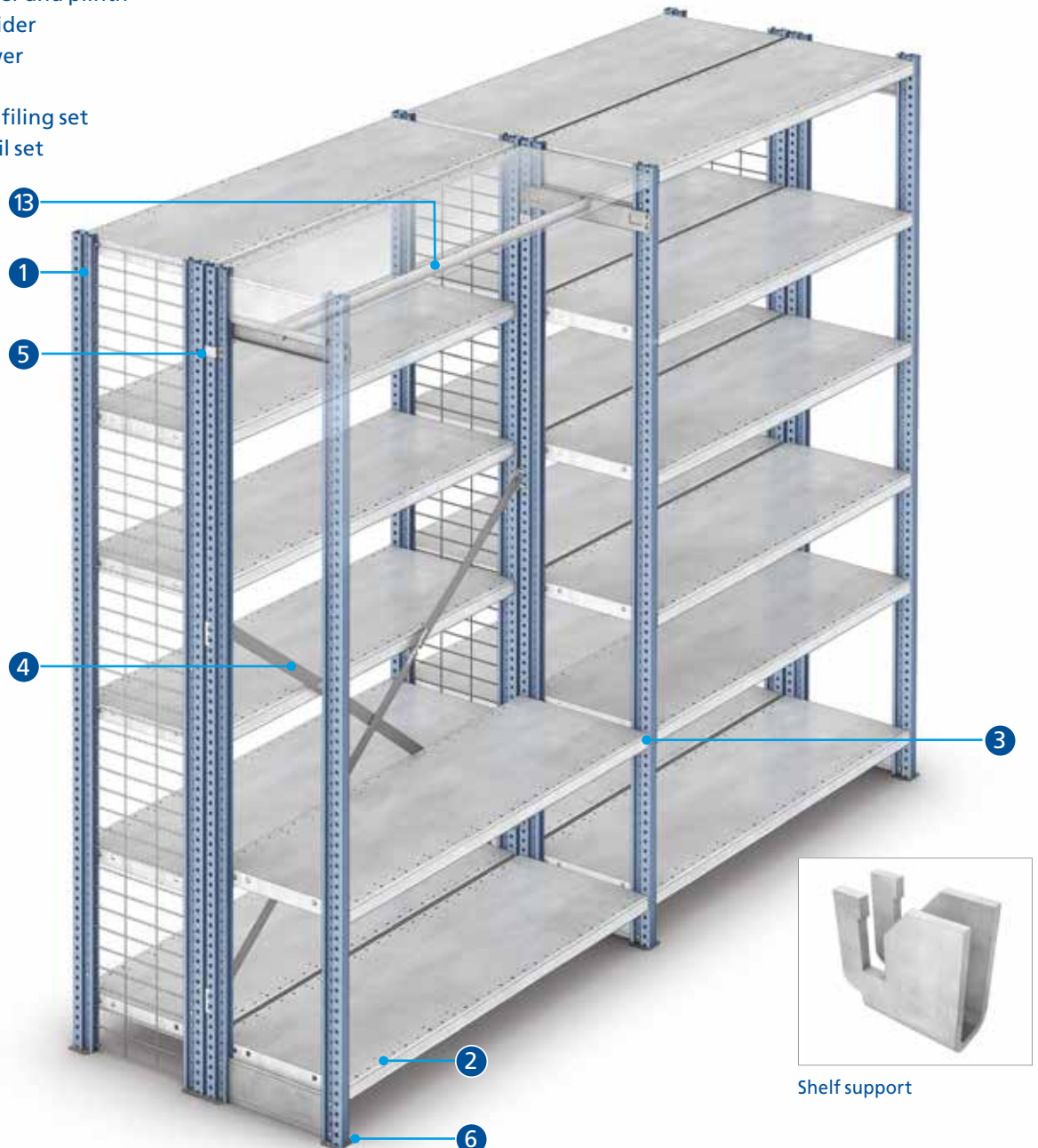

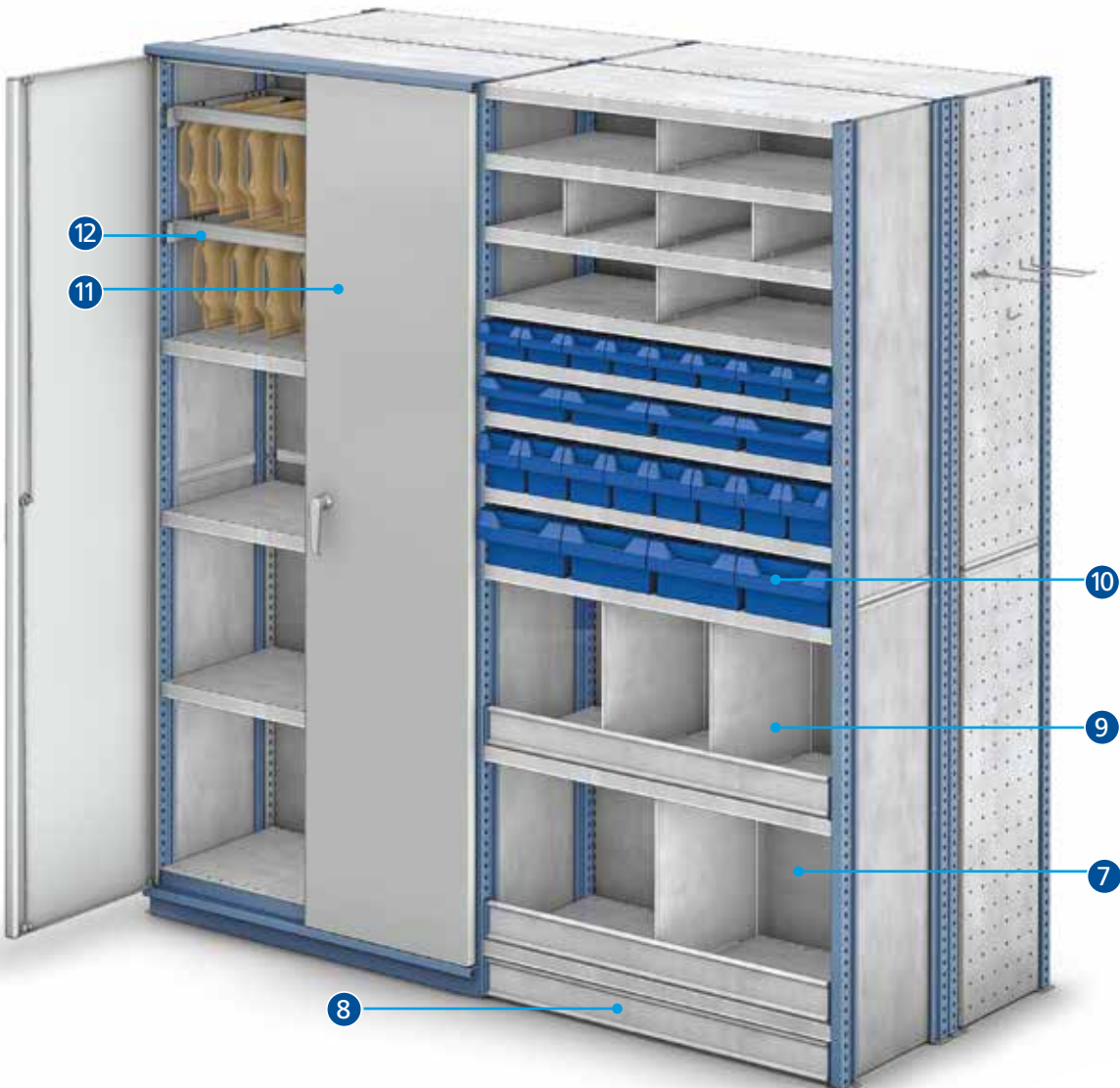

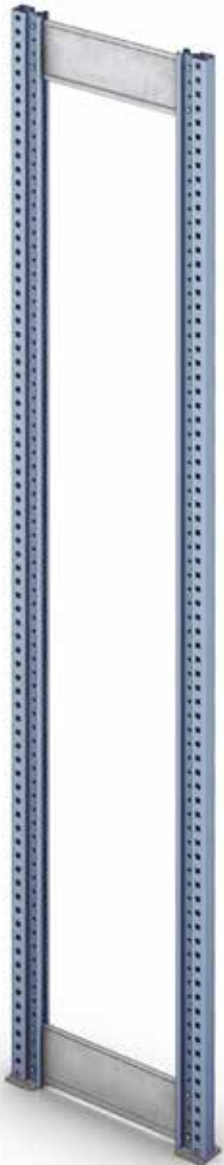

### Frames

Vertical elements created by two uprights joined together with cross ties, side panels or sets of cross ties and diagonals providing the necessary rigidity.

The basic frame is made up of two uprights, cross ties and footplates.

The number of cross ties depends basically on the height of the frame. The minimum number used is two.

The most common frame heights are: 1,500, 2,000, 2,500, 2,750, 3,000 and 4,000 mm. They can be manufactured up to 8,000 mm long.

### Uprights

There are two types of uprights, depending on the load and the application, with either 6 or 12 folds. Both types have lateral slots every 25 mm for the insertion of shelf supports and accessories. The face of the upright is plain, thus providing an attractive finish.

The front measures just 30 mm, resulting in increased work space. The goods are supported laterally on a wide, edge-free surface.



Painted uprights



Galvanised uprights



### Plastic footplates

These are fitted to the bottom of the uprights, guaranteeing good support so the uprights do not come in direct contact with the floor.



### Levelling plates

These can be combined with either metal or plastic footplates and are used to correct minor irregularities in uneven floors.



### Metal footplates

Suitable for heavy loads, as they distribute the weight over the floor.



### Frame cross ties

The cross ties slid down inside the uprights until the fixing point is reached, making the set extremely rigid.

At least two are fitted, depending on the height of the frame.  
The uprights can be manufactured in heights of up to 8 m.



### Frame unions

These join two frames back to back to make double shelves.



### Upright splices

These are used for units that are more than 8 m in height and whenever it is necessary to splice two uprights.

**Frame options**

In addition to the basic frame construction system, the following can also be made:

**Frames with cross ties and diagonals**

These are basic frames which, in addition to cross ties, include crossed diagonals to increase the level of rigidity in frames of considerable height.

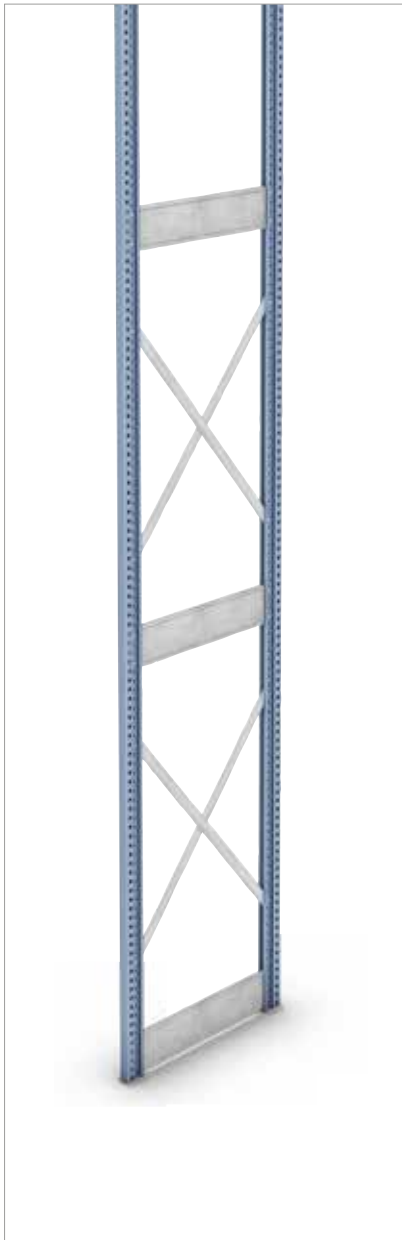

**Frames with central metal panelling**

These are closed frames that stop products stored on adjacent levels from getting mixed together. The metal panels are made in sections and joined together using panel splices.



**Frames with metal side panelling**

These are similar to frames with central panelling. They give an improved, exterior finish to the frames or can be used to create double-panel frames to avoid empty spaces between shelves and the metal. Metal side panelling can be drilled to hold hooks or other accessories.

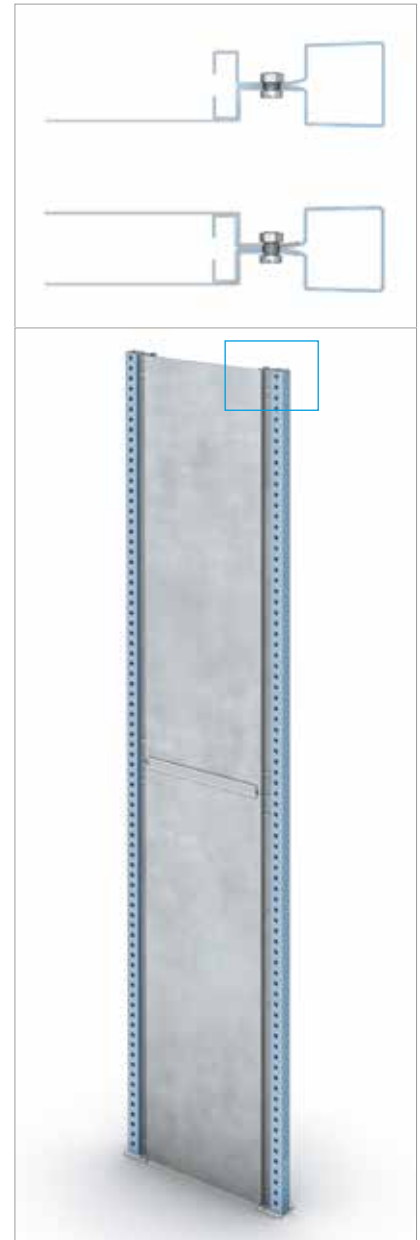





### Frames with metal meshing

These prevent goods from falling off the side, as well as allowing a lateral view of the product and providing better ventilation.

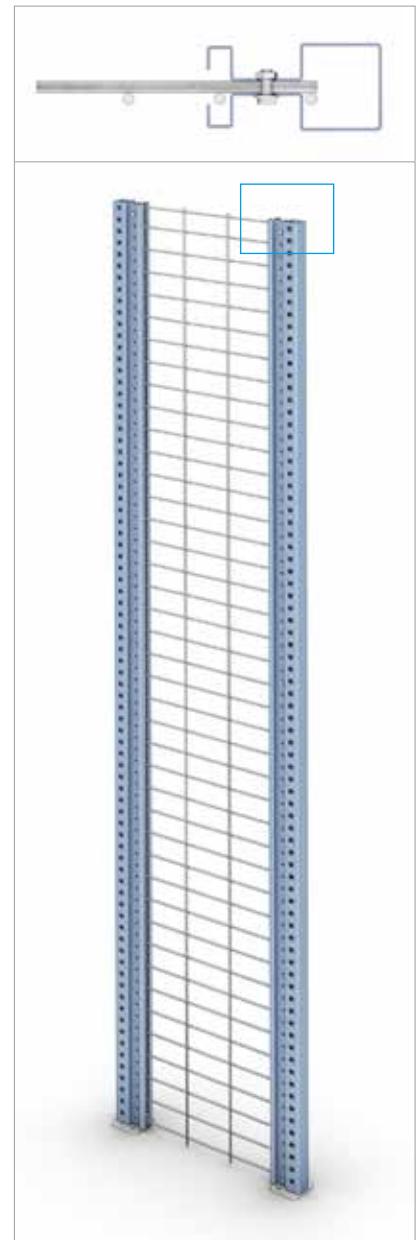



### Metal shelves

These are the basic elements for creating load levels. They are made from a single piece of galvanised metal with several folds to ensure a large, uniform load capacity.

The metal shelves are joined to the uprights using supports. The shape of these supports makes the joint between the shelves and the uprights more rigid, as the load weight increases.



Supports

The most common metal shelf sizes are:

Length: 750, 1,000, 1,250 and 1,400 mm  
Depth: 300, 400, 500 and 600 mm

Two different models are available, depending on the load capacity:

- Shelves for light loads.
- Shelves for medium and heavy loads.

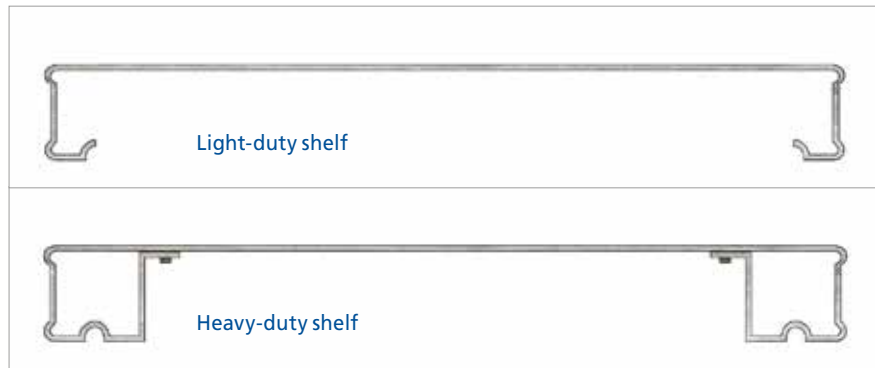

The various folds on the front and back of the heavy-duty shelves create a rounded edge, which increases the load capacity. These shelves can be supplied in the slotted option, allowing usage of vertical dividers and accessories.

The channel on the front can be used to attach magnetic holders for identification labels.



#### **Shelf reinforcer**

Heavy-duty shelves can be fitted with a central reinforcer along their length to increase their load capacity.



#### **Shelf joint**

These are placed whenever it is necessary to cover the gap between two shelves.

**Cross-bracing sets**

Cross-bracing sets are vital for the stability and longitudinal rigidity of the shelving.

They are attached to the side slots at the back of the uprights to tighten and stabilise the unit.



Front view



Back view



### Number of cross-braces

The number of cross-braces used is variable, depending on the height, the number of shelving units and the stored loads.

Just one cross-brace is placed in shelving units of up to 2,5 m in height (figure 1), and two are used for higher units (figure 2).



Figure 1

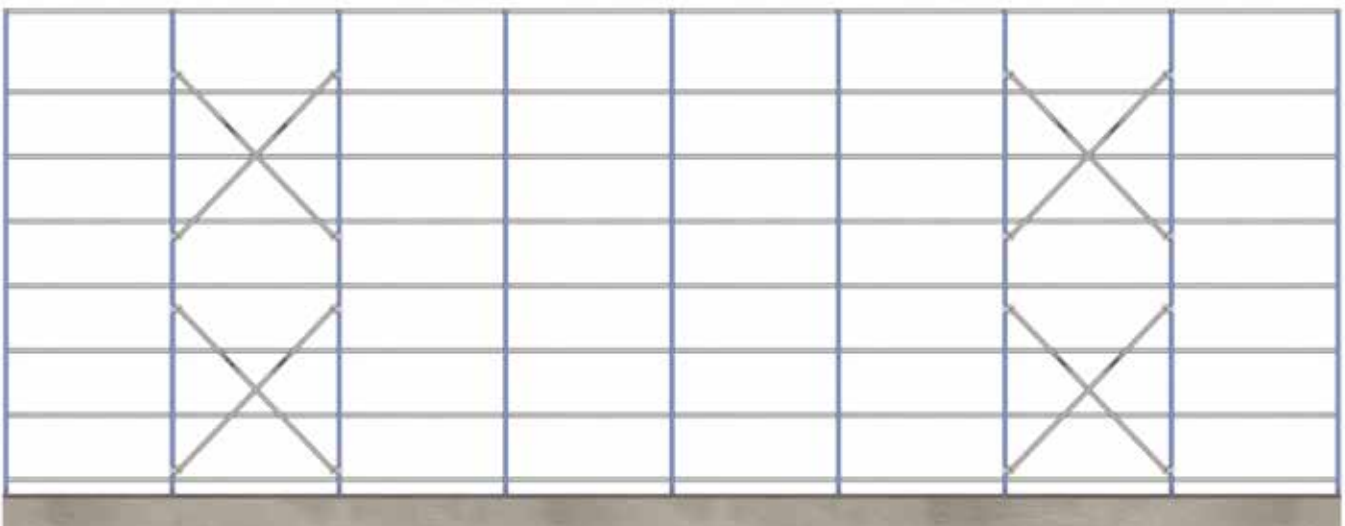
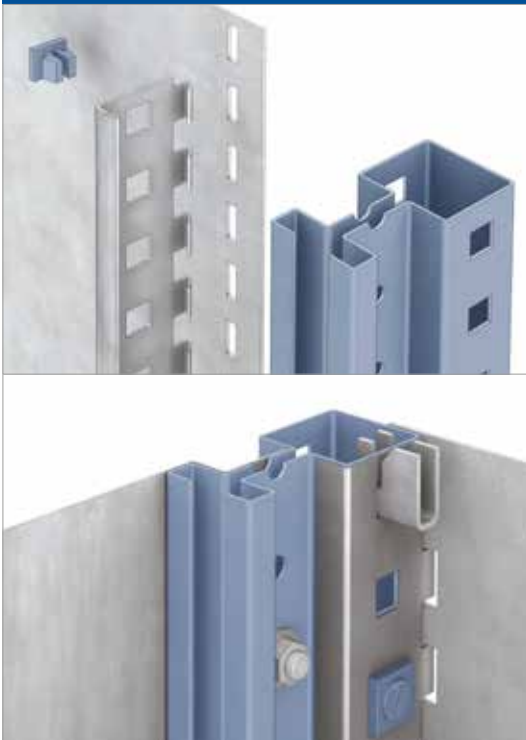

Figure 2

# Accessories

Highly versatile accessories and professional finishes



## Metallic back panels

These are used to close in the rear of the shelving units, to stop items from falling out the back of a single unit or to stop products from mixing within double units.

The panels are attached to the upright tabs that fit into the panel slots. Clips secure the tabs to the uprights and to the level supports.

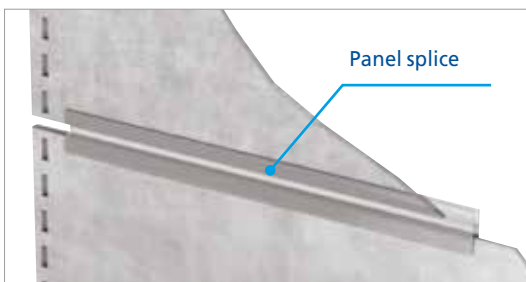

## Panel splices

These are used to splice both the frame and back panelling. They are made of plastic and level out the heights of two adjoining panels.



### Back reinforcers

For single shelving units, back panel reinforcers are fitted to the rear. These are attached to the tabs of the back panels with reinforcement clips.

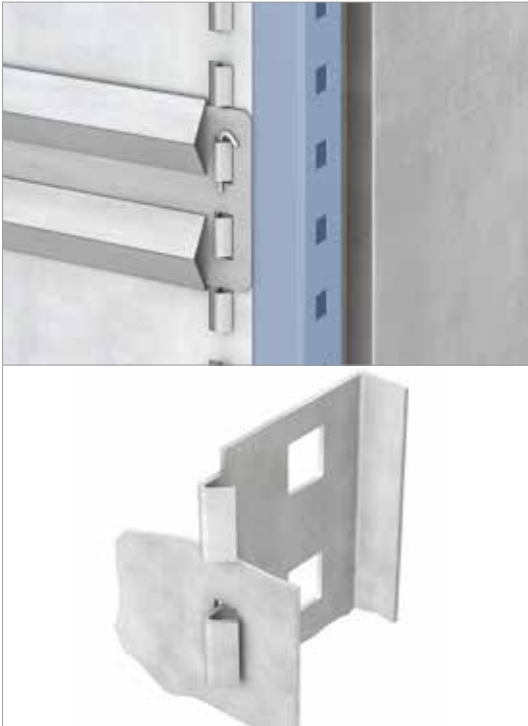

Reinforcer

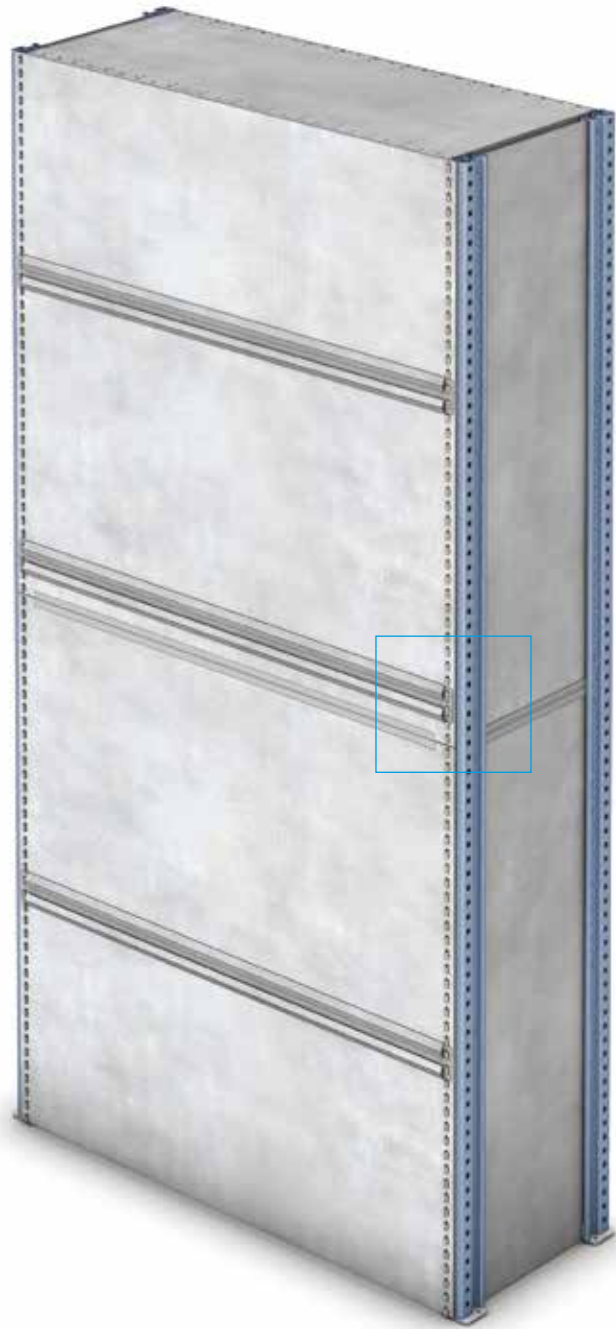

In double units, the panels are fixed alternately to one side or the other of the shelving.

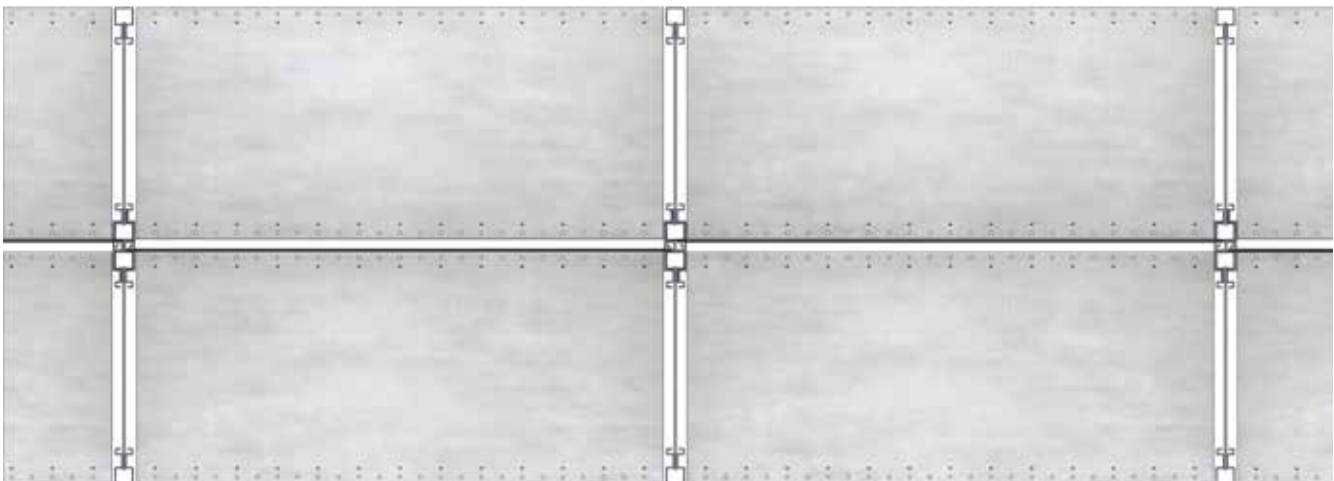

### Mesh backing

This has the same function as back panels. However, this accessory permits light and air to pass through the shelves. It is attached to the uprights using mesh fasteners.

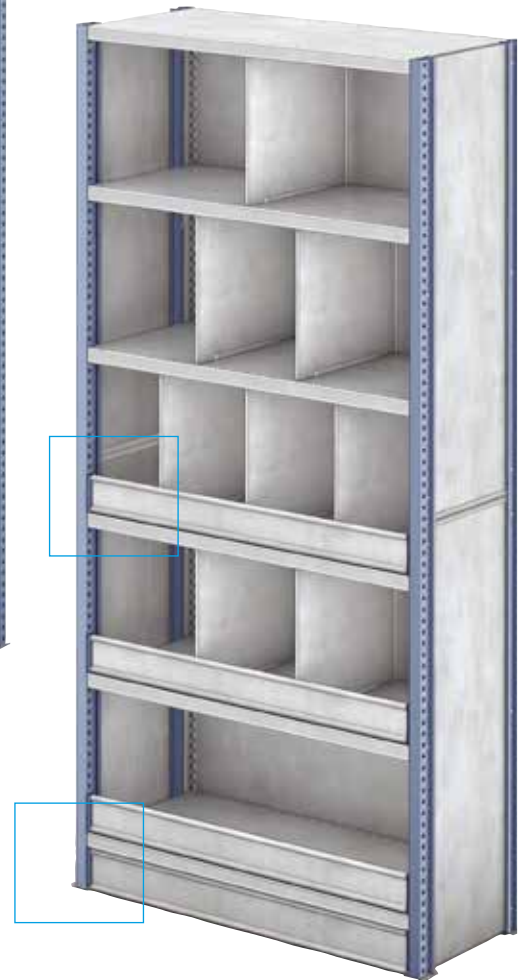
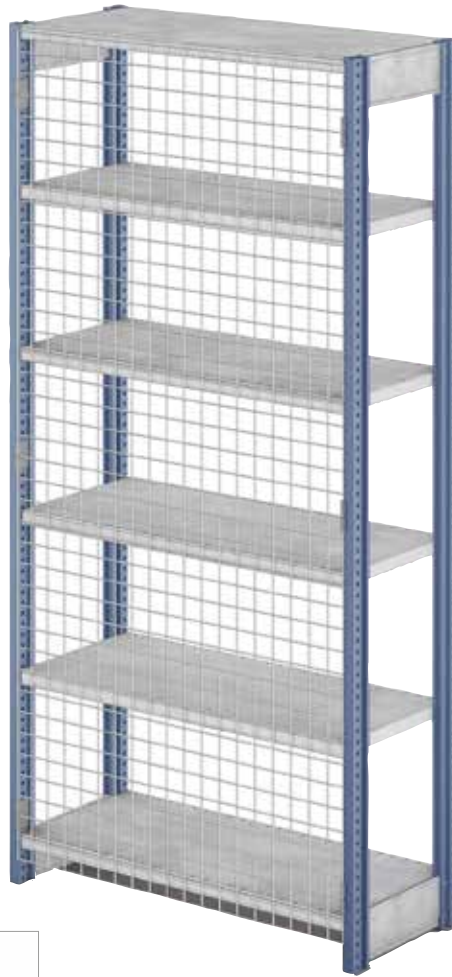

Detail of mesh fastener.

### Plinths and shelf retainers

This set performs two different functions: it acts as a plinth to stop objects from going under the units and it prevents products from falling off the front of the levels. It is attached to the shelf uprights using two fasteners, one on each side.



Set with shelf retainer.

Set with plinth.





### Slotted shelf dividers

These divide the space vertically, making smaller compartments in levels comprised of metal shelves.

They attach to the slots on the shelves, and can be installed in two ways:

- Attached to the upper and lower shelves, dividing the whole height of the shelf.
- Only attached to the lower shelf.

They are available in different heights and depths.

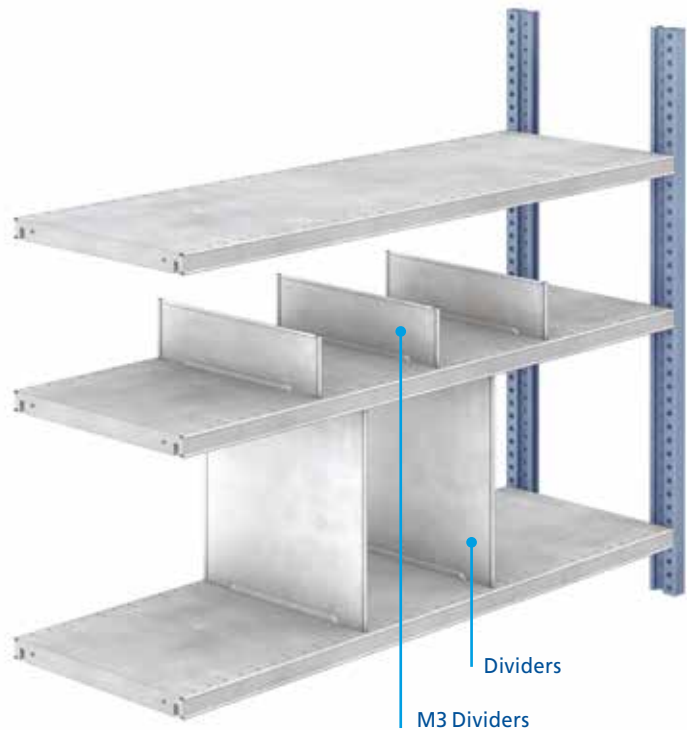

Heigh	Depth
100*	300
	400
	500
225	300
	400
	500
300	300
	400
	500
400	300
	400
	500
500	300
	400
	500
550	300
	400
	500

(in mm)  
\* Only for M3 dividers

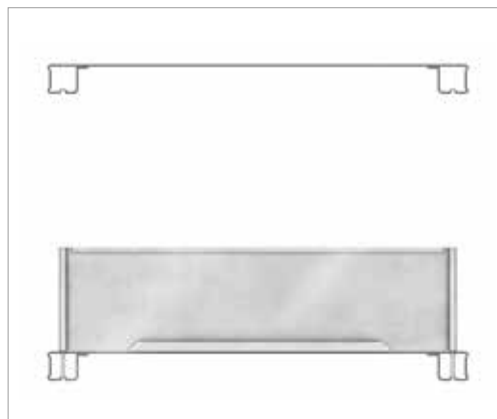

Detail of attachment to lower shelf, only used with 100 mm high dividers.



Detail of attachment to upper and lower shelf.

### Shelf structure

Shelves made up of two structural cross ties and from two to five structural beams, depending on the depth of the shelf to be made, the size of the boxes to be stored and the weight of the goods.

They are ideal for situations where the shelves must allow water from fire sprinklers to flow through the racks, as most of the surface is open.

The cross ties fit into the slots in the uprights, while the beams fit into the different housings incorporated into the cross ties for this purpose.



The number of beams varies, according to the depth of the shelving and the load to be supported.

### Mesh shelves

Shelves made of electro-welded metal mesh that rest on the shelving structure.

They are designed to allow water to flow through if the fire protection system is activated. The mesh segments are 50 x 50 mm in size, which allow storage of various sized boxes.

Cross ties can also be incorporated, depending on the load that must be supported.

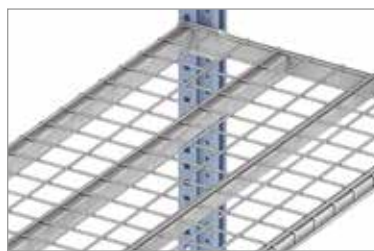

Detail of cross ties

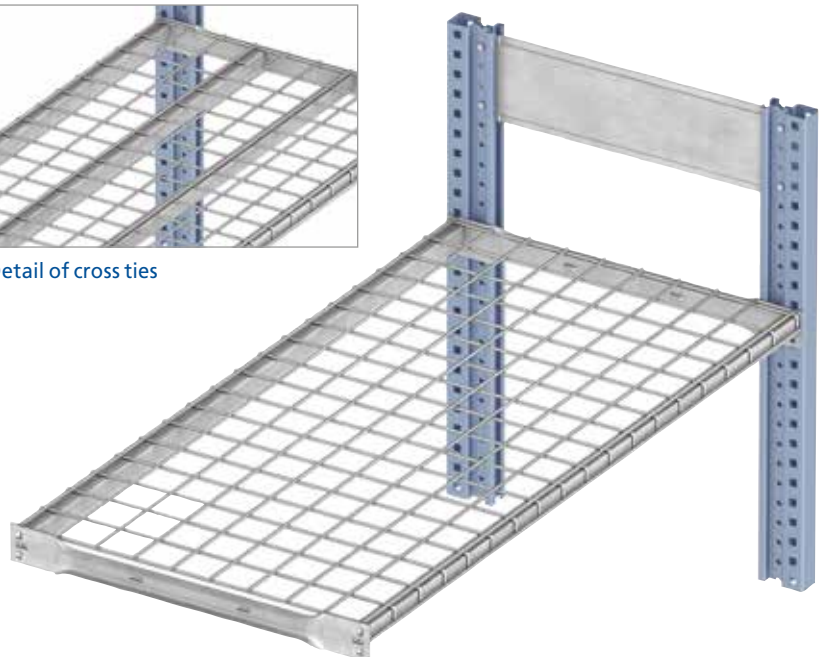



### Doors

Units that are 1,000 mm long can be fitted with metal doors to make closed cupboards.

They are manufactured in two standard heights, 1,000 and 2,000 mm. They consist of two doors with a beam at the top and another at the bottom, and a lock.

They are attached to the front uprights of the frames.

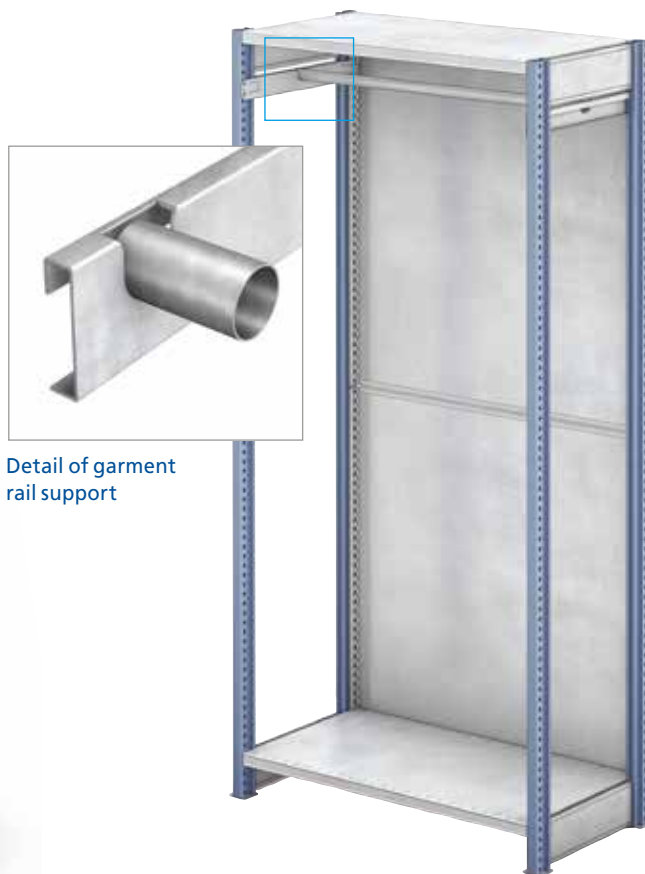

Detail of garment rail support

### Garment rail supports

The garment rail support sets are used for hanging clothes, samples or other products stored in the shelving units.

Both single sets, with just one rail, and double sets are available. As well as for hanging products, the double sets can store cylindrical items by resting them on the two rails.





### Magnetic label holders

These are magnetic plastic holders that are fitted to the front of the light-duty shelves to mark the levels or compartments on the levels or to identify the products stored. They fit into the groove at the front of the shelves. There are two models:

**Model A.** The front surface has a white plastic finish, which can be permanently labelled.

**Model B.** A sleeve with two guides into which a removable label of appropriate size can be inserted into the holder. The label is protected by a plastic cover.



Model A



Model B



### Index card holder

Made from clear plastic, it can be attached to the sides of the shelving units and used to hold either permanent or interchangeable index cards.



### Lateral sign plate

These identify the shelving unit by means of numbers, letters or index card holders. They can be read from both the access aisle and the inside of the shelving unit.

They are attached to the side grooves in the frame uprights.

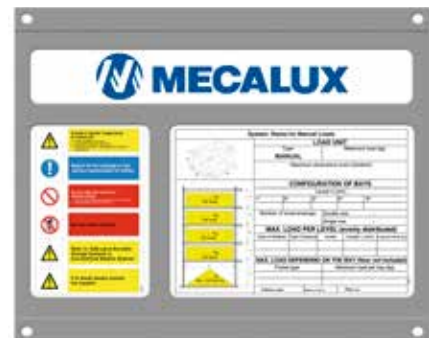

### Technical plate

These plaques specify the installation characteristics. They are placed in visible areas at the ends of the shelving units.

### Removable plastic drawers

These are specially designed to suit the shelving units. They allow the user to store and sort small objects.

Their careful design, the reinforcements, the grooves for dividers, the retention system, the label holder, their durability and easy access handle make the drawers the perfect accessory for picking shelves with small-sized products.

The drawers are made from polypropylene, have a large load capacity and are robust.

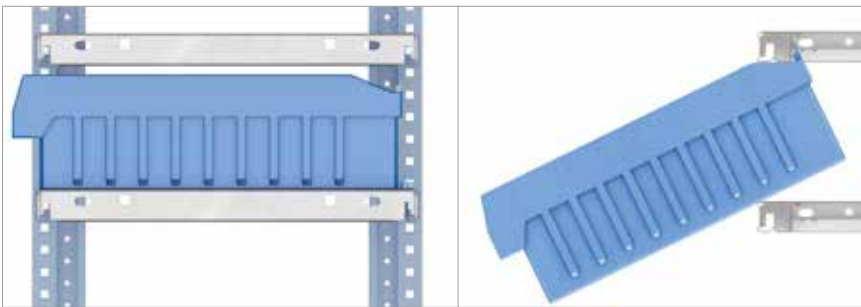
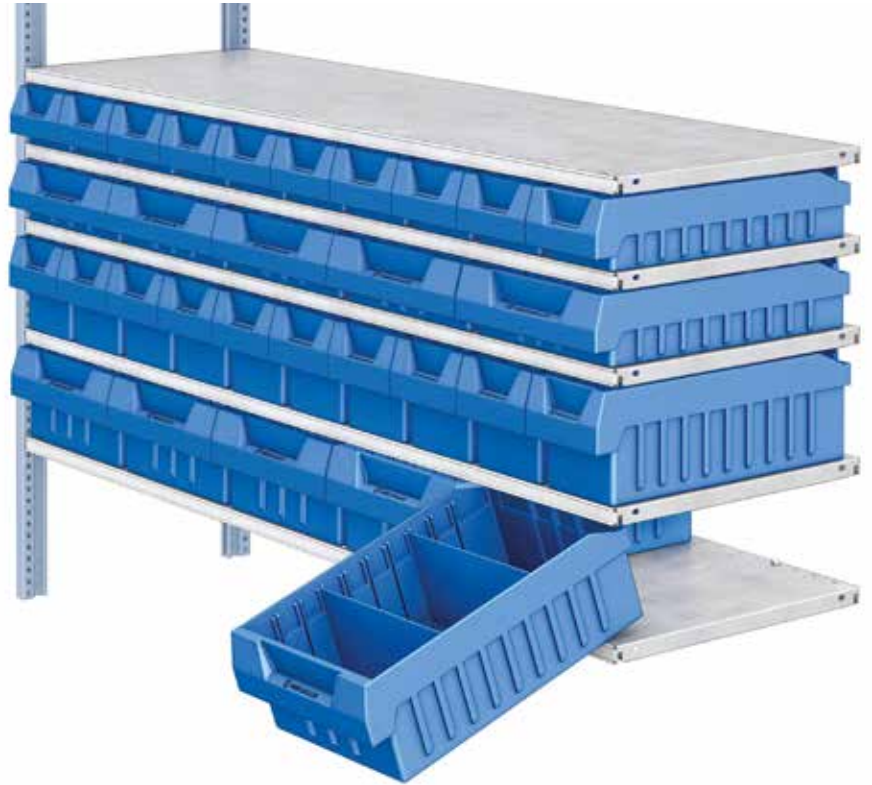

The drawers fit between two shelves. When they are pulled out to access the products, a slight twist hooks them to the upper shelf. This stops the drawer from falling and makes accessing the contents easier.



A stop at the back limits how far the drawer can be pushed in, leaving the handle accessible at all time.

There are a number of different accessories, such as:



#### Labels

These are made of card and allow the SKU reference or product code stored inside to be written or stuck on.



#### Transverse dividers

These subdivide the drawer crosswise into different-sized compartments. Model A dividers have label holders.



#### Longitudinal dividers

These subdivide 246 mm wide drawers into two or three compartments. They can be placed in three positions.

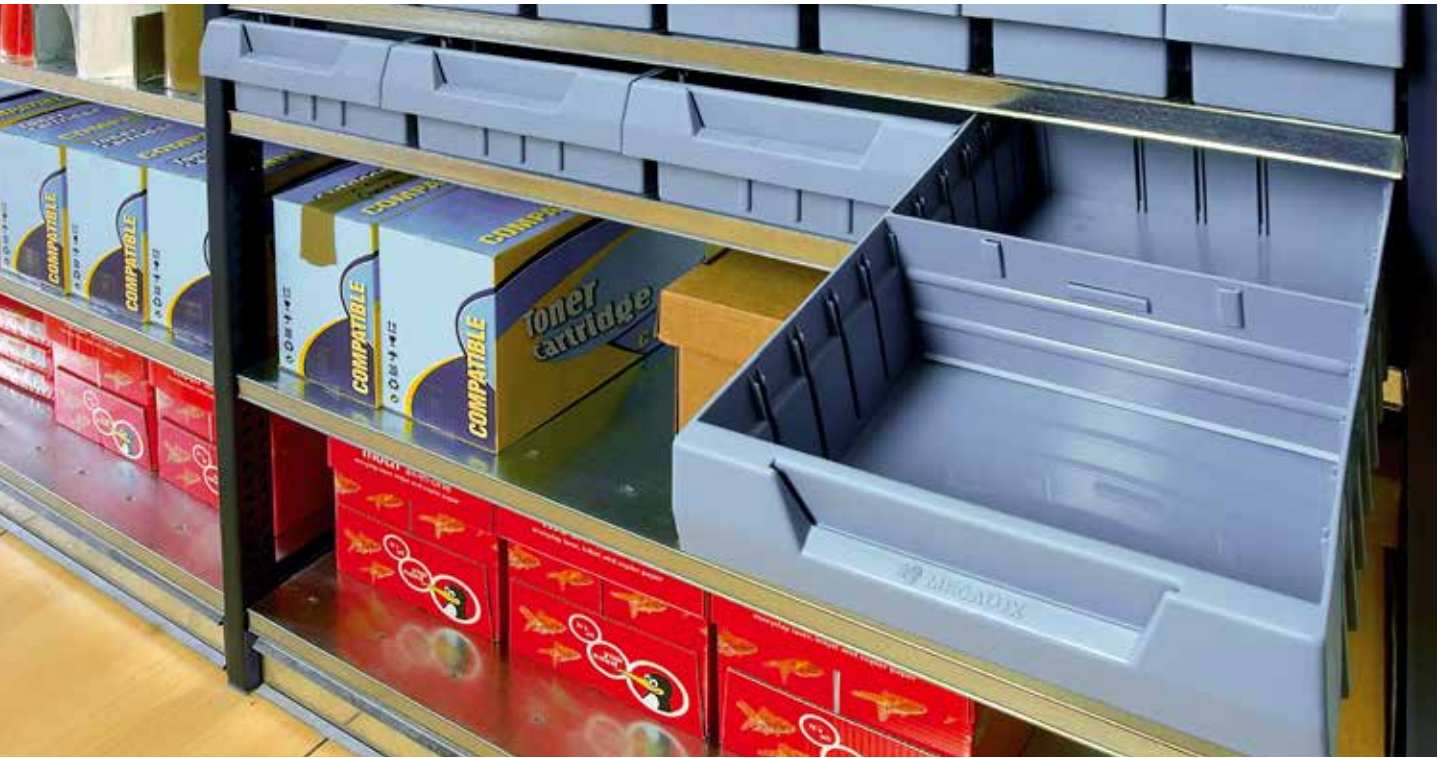

### Four models in three depths

There are four different models, each of which comes in three depths.

When choosing the most suitable model, the type of product to be stored and the depth of the shelving should be taken into account.

The drawer models are defined as follows:

- The first two letters show the model height.
- The next two numbers are the depth of the shelving in centimetres.
- The last two numbers are the width of the drawer in centimetres.



Model MA



Model MA



Model MB



Model MB

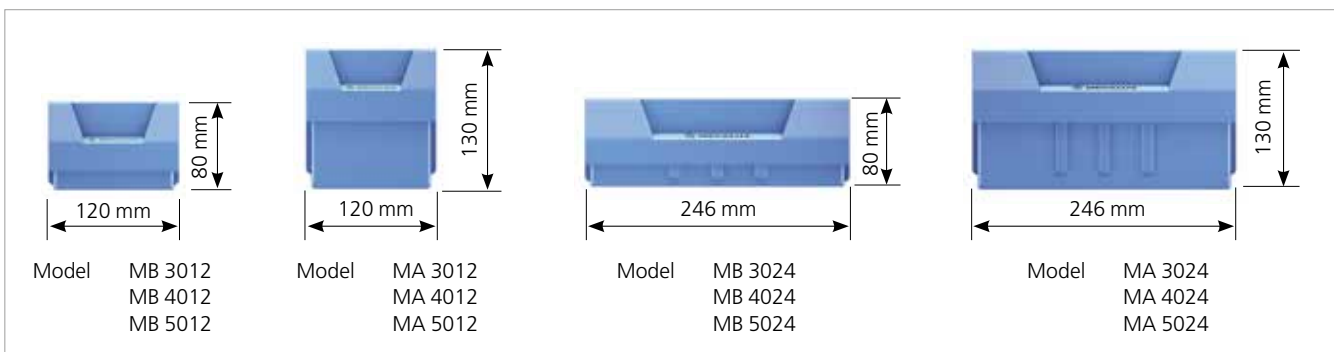



The following diagrams illustrate the capacity of the drawers by level and their specifications.

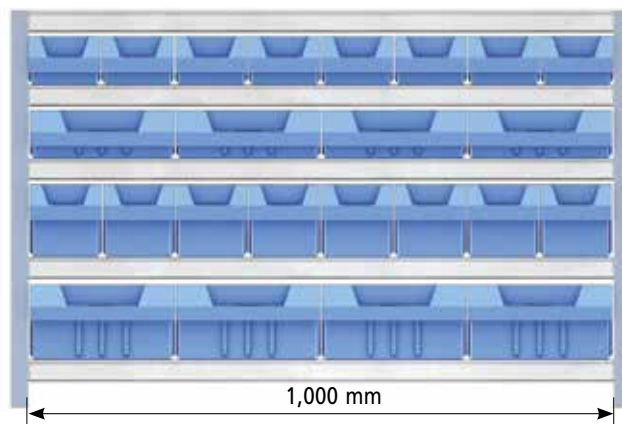

The following would fit on a 1,000 mm level:

- 4 MA 3024, 4024, or 5024 drawers
- 4 MB 3024, 4024, or 5024 drawers
- 8 MA 3012, 4012, or 5012 drawers
- 8 MB 3012, 4012, or 5012 drawers

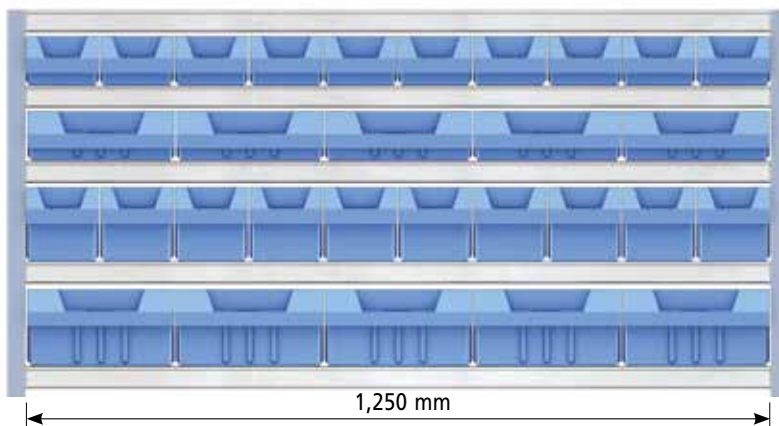

The following would fit on a 1,250 mm level:

- 5 MA 3024, 4024, or 5024 drawers
- 5 MB 3024, 4024, or 5024 drawers
- 10 MA 3012, 4012, or 5012 drawers
- 10 MB 3012, 4012, or 5012 drawers



## Stackable plastic bins

Useful in warehouses that handle multiple and small-sized SKUs, such as parts warehouses, workshops or manufacturing plants.

They can be used as independent units for classification and storage, or they can be joined by a union clip to form a compact drawer system. When placed in shelving, the ease and speed of locating products is significantly improved.

They are made of polystyrene, which makes them long-lasting and highly cost-effective.

The models available are:



Type	Width	Depth	Height
2	302	500/600	200
3	210	350/300	200
4	149	230/200	130
5	101	160/140	75

In mm.



### Custom solutions

In addition to the previously mentioned components, which facilitate storage of any kind of product, there are also specific items for spare parts (doors, windows, side panels, exhaust pipes, tyres, etc.) and irregularly-sized products (dies, samples, profiles, cylindrical items, etc.).

These elements can also be used to sort and store other products of similar characteristics.

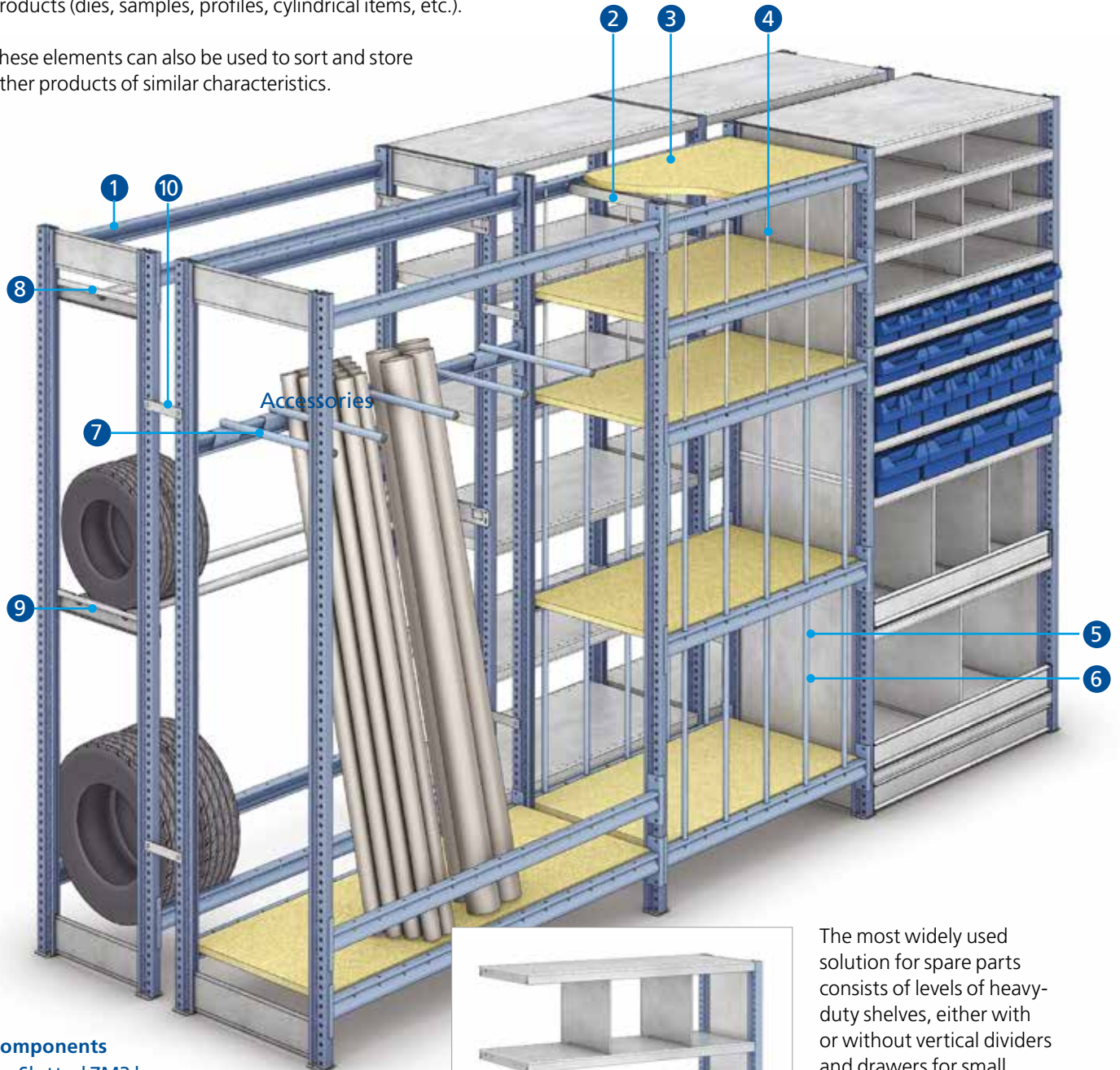

#### Components

1. Slotted ZM3 beam
2. ZM3 cross ties
3. Chipboard shelf
4. Vertical rail divider
5. Vertical tube divider
6. Plastic cover for vertical tubes
7. Horizontal divider
8. Single garment rail set
9. Double garment rail set
10. Frame union



The most widely used solution for spare parts consists of levels of heavy-duty shelves, either with or without vertical dividers and drawers for small accessories.

#### Vertical rail dividers (4)

Levels made up of slotted ZM3 beams with tubes or vertical rail dividers allow you to store and sort metal items that are irregular in shape, such as bumpers, metal side panels and doors, etc.



#### Chipboard shelves (3, 5 & 6)

Levels made up of beams, cross ties and chipboard are installed to store heavy or rough items.

Levels made up of beams, cross ties and chipboard that also have vertical dividers can store more delicate items or products that need constant support, such as panes of glass.

Vertical dividers can be fitted with **covers** made of flexible plastic tubing, to prevent the product from rubbing directly against the metal tubes (figure 3).

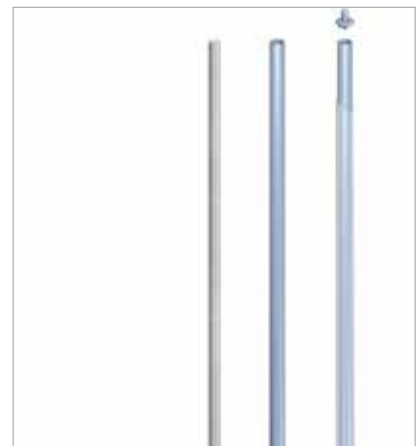
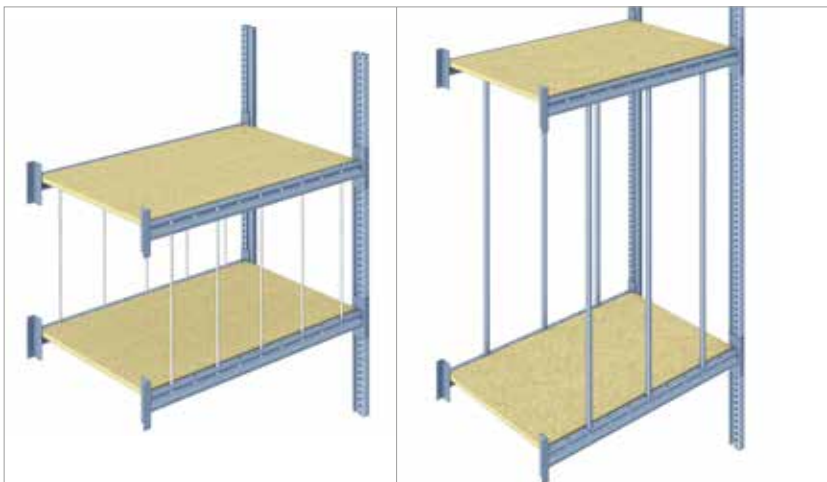
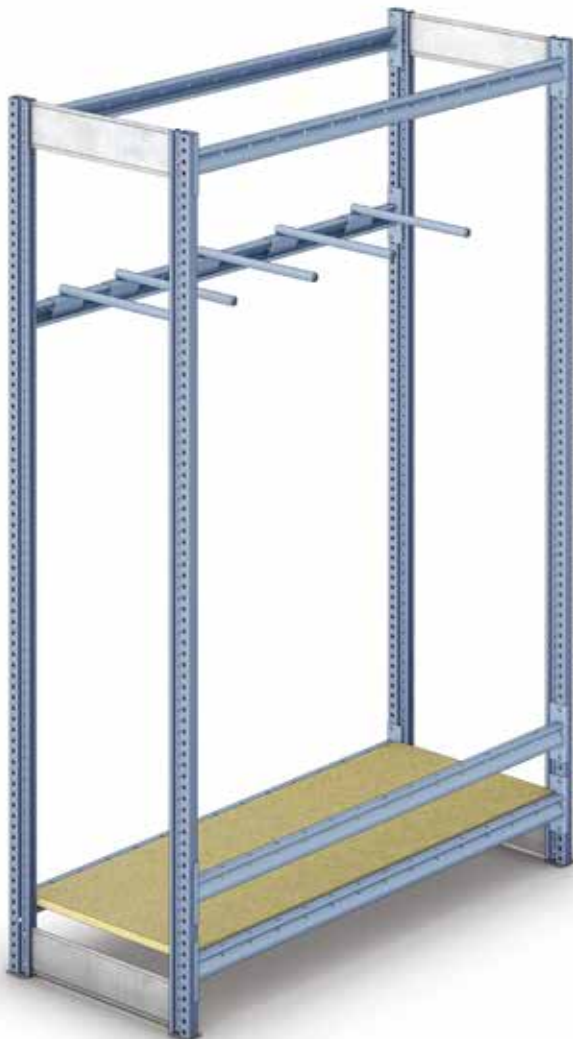

Figure 3

**Beams ZM3 (1)**

By using only beams, you can store products that protrude off both sides. Tyres can also be stored depending on the depth of the shelf.



**Horizontal dividers (7)**

Slotted LZ beams can have horizontal dividers to store profiles, exhaust pipes, and other products vertically.

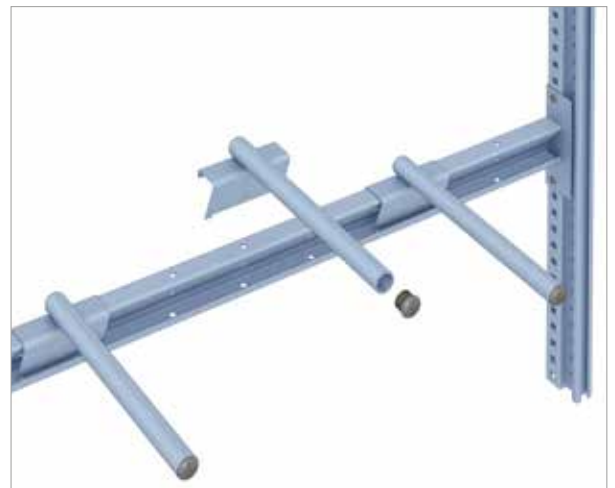

### Garment rail sets (8 & 9)

Double garment rail sets can be used to create levels for storing tyres, hubcaps or other cylindrical items, or for double depth storage of products that do not have sufficient support.



Single support and garment rail



Double support and garment rail



### Side hooks

These slot on to frames with perforated sides. They can be placed for hanging samples, bags and other products to the front of the shelving units.

There are three hook models.

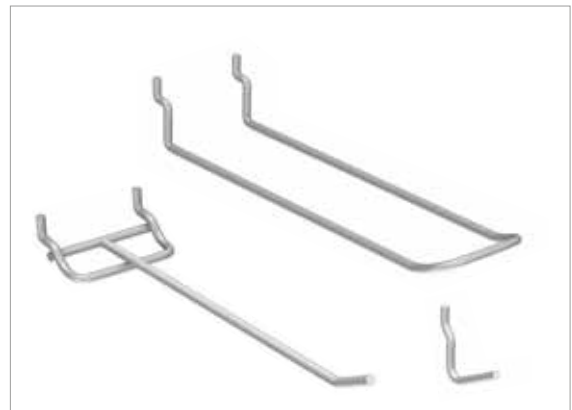

# Uses

Ideal for installations where order, classification and easy access are essential

## In your office

M3 shelving is ideal for offices, businesses and places that need a more professional looking system.

The different components are painted in Blue Ral 5014 (frame uprights) and Grey Ral 7035 (other components).

The most common combinations are shown in the following illustrations.



Detail of suspension filing set

## Components

1. Suspension filing set
2. Garment rail set
3. Book divider
4. Vertical divider
5. Lateral retainer
6. Door

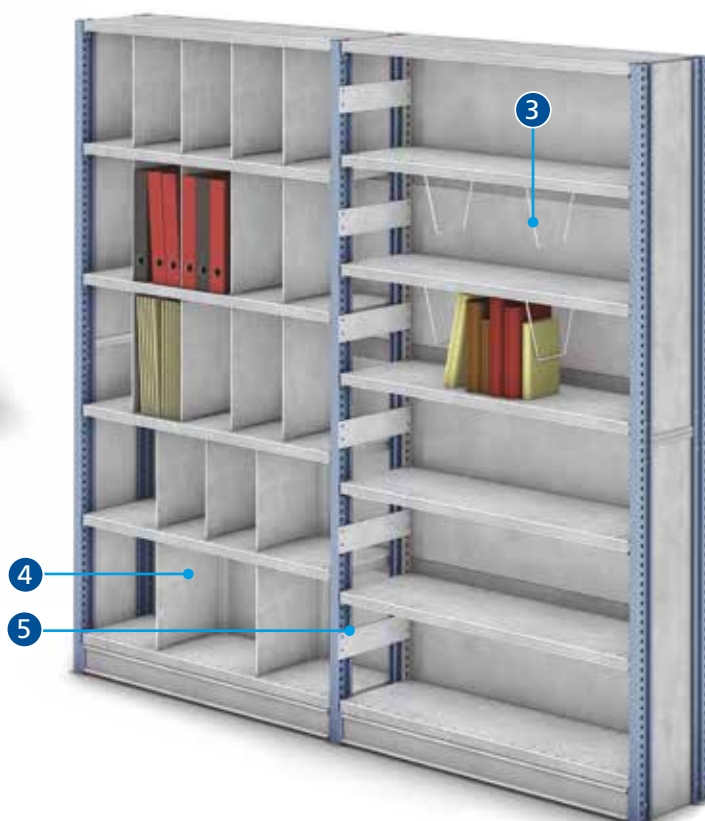



**Book dividers (3), lateral retainers (5) and vertical dividers (4)** section off the space, creating compartments for books or files.

The garment rail set (2) can be used to hang clothes and to create closed wardrobes with the addition of doors, as well as side and rear metal panels.



The support profiles can be attached to the **suspension filing set (1)** at the correct distance to hold the most commonly-available folders.

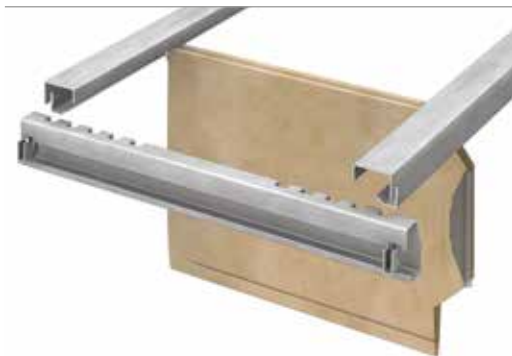



**HEAD OFFICE - SPAIN** - Silici, 1 - 08940 Cornellà de Llobregat - Barcelona  
**Tel. +34 932 616 913 – info@mecalux.com – mecalux.com**

**EUROPE**

**BELGIUM**

Tel. +32 2 346 90 71  
info@mecalux.be  
**mecalux.be**

**CZECHIA**

Tel. +420 222 524 240  
info@mecalux.cz  
**mecalux.cz**

**FRANCE**

Tel. +33 01 60 11 92 92  
info@mecalux.fr  
**mecalux.fr**

**GERMANY**

Tel. +49 (0) 2133 5065 0  
info@mecalux.de  
**mecalux.de**

**ITALY**

Tel. +39 02 98836601  
info@mecalux.it  
**mecalux.it**

**NETHERLANDS**

Tel. +31 208 08 30 96  
info@mecalux.nl  
**mecalux.nl**

**POLAND**

Tel. +48 32-331 69 66  
info@mecalux.pl  
**mecalux.pl**

**PORTUGAL**

Tel. +351 21 415 18 90  
info@mecalux.pt  
**mecalux.pt**

**SLOVAKIA**

Tel. +421 220 545 117  
info@mecalux.sk  
**mecalux.sk**

**TURKEY**

Tel. +90 216 706 10 15  
info@mecalux.com.tr  
**mecalux.com.tr**

**UNITED KINGDOM**

Tel. +44 0121 3336 602  
info@mecalux.co.uk  
**mecalux.co.uk**

**AMERICA**

**ARGENTINA**  
Tel. +54 (11) 4006-4444  
info@mecalux.com.ar  
**mecalux.com.ar**

**BRAZIL**

Tel. +55 19 3809-6800  
info@mecalux.com.br  
**mecalux.com.br**

**CHILE**

Tel. +56 (2) 2827 6000  
info@mecalux.cl  
**mecalux.cl**

**COLOMBIA**

Tel. +57 01 8000 423 553  
info@mecalux.com.co  
**mecalux.com.co**

**MEXICO**

Tel. +52 (664) 647 22 00  
info@mecalux.com.mx  
**mecalux.com.mx**

**URUGUAY**

Tel. +598 2683-8879  
info@mecalux.com.uy  
**mecalux.com.uy**

**USA**

Tel. 1-877-632-2589  
info@interlakemecalux.com  
**interlakemecalux.com**

